

# ELBA

## **B.I. INDUCTION CERAMIC HOB MODEL: EICH-G3622ST(BK)**

### **Owner's Manual**

Please read this manual carefully before operating your set.

Retain it for future reference.

Record model number and serial number of the set.

See the label attached on the set and quote this information to your dealer when you require service.

**For The Warranty Terms & Conditions, Please Refer To Warranty Certificate**

We recommend that you read the instructions in this owner's manual carefully before using it for the best performance and to extend the lifespan of your appliance, as it will provide you with all the instructions you require to ensure its safe installation, use and maintenance.

## **Safety Precautions**

- Edges of the appliance may be sharp, extra cautions must be paid to protect injury cause by the sharp edges.
- To ensure your safety, all electric appliances should only be installed or serviced by qualified technician. If the supply cord is damaged, it must be replaced by the authorized service center or similarly qualified technician in order to avoid hazard.
- Do not place supply cord on the edge of table and counter, or near any heating appliance.
- In order to avoid electric shock, do not immerse supply cord, plug or other parts into water.
- Do not place the appliance near electric stove, heated oven, microwave or other heat source.
- In order to avoid burning or explosion, combustibles or flammable material (curtains, cloth, wallpaper and others) should be kept away from the appliance.
- Do not place plastic or other similar items on the cooktop.
- This appliance has to be properly installed and earthed, with a connecting fuse with the load of 15A.
- The glass surface may become hot during use. Please keep away from children and never touch the glass by bare hands.
- Disconnect the appliance from the power supply and wait until it is cool before cleaning or maintenance.
- In order to avoid electric shock, never use wire brush to clean the appliance since pieces of metal is easy to touch live part.

- Never use metal scouring pads or sharp scrapers which will damage the glass surface leading to broken or scratches.
- In order to avoid burn or electric shock, never put too much food or metal utensils on the cooktop.
- Please make sure the hob function has been switched off when it is not be used and unplug from the socket when you are planning not to use the appliance for long time.
- Never use your oven outside the built-in cabinet.
- Other purpose except cooking is not allowed.
- Do not rest heavy object on the glass surface. This may damage the glass.
- Do not cook on a broken or cracked cooktop. If the cooktop surface has been broken, switch off the appliance immediately at the electrical mains and contact the service center.
- Never leave the appliance unattended when in use.
- This appliance is not intended for use by persons (including children) with reduced physical sensory or mental capabilities, or lack of experience and knowledge, unless they have been given supervision or instruction concerning use of the appliance by a person responsible for their safety.
- Do not use a steam cleaner to clean your cooktop.
- Do not cook the food directly on the glass surface without any cooking utensils.

# Installation

## Selection of installation equipment

1. Cut out the work surface according to the sizes shown in the drawing. For the purpose of installation and use, a minimum of 50mm space shall be preserved around the hole. Be sure that the thickness of the work surface is at least 30mm. Please select heat-resistant work surface material to avoid larger deformation caused by the heat radiation from the appliance. Installation as shown below:

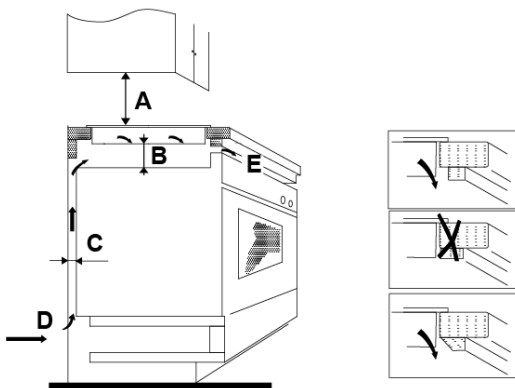

A(mm)	B(mm)	C(mm)	D	E
760	50 mini	30 mini	Air intake	Air exit 10 mm

Under any circumstances, make sure the hob is well ventilated and the air inlet and outlet are not blocked. Ensure the hob is in good working condition as shown above.



Note: The safety distance between the hotplate and the cupboard above the hotplate should be at least 760mm.

## Before locating the fixing brackets

The unit should be placed on a stable, smooth surface (use the packaging). Do not apply force onto the controls protruding from the hob. Fix the hob on the work surface by screw four brackets on the bottom of hob (see picture) after installation. Adjust the bracket position to suit for different work surface's thickness.

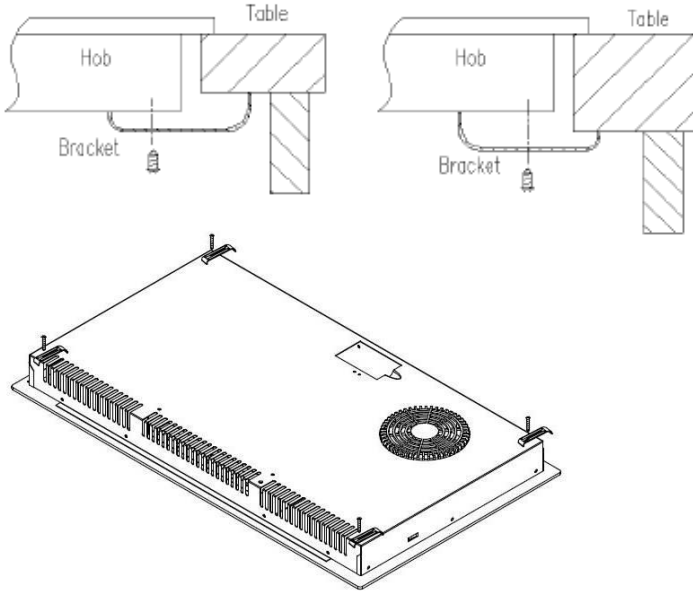

## Connecting the hob to the mains power supply

The power supply should be connected in compliance with the relevant standard, or a single-pole circuit breaker. The method of connection is shown below.

1. If the cable is damaged or needs replacing, this should be done by an authorized technician using the proper tools, so as to avoid any accidents.
2. If the appliance is being connected directly to the mains supply, an omnipolar circuit breaker must be installed with a minimum gap of 3mm between the contacts.
3. The installer must ensure that the correct electrical connection has been made and it complies with the safety regulations.
4. The cable must not be bent or compressed and shall be checked regularly.

# Product Overview

## Top View

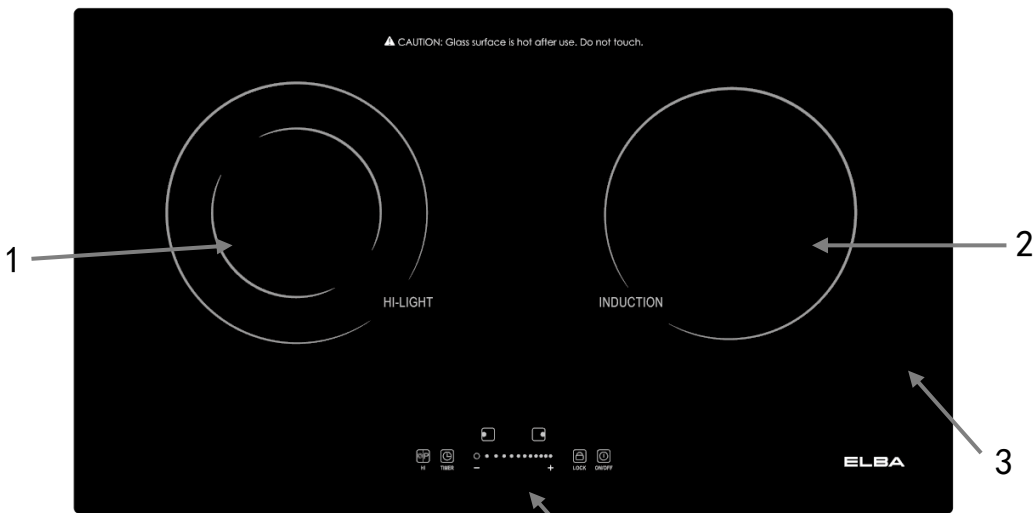

1. Min/Max. 1100/2200 W zone
2. Min/Max. 1800/2100 W zone
3. Glass Cook Top
4. Control panel

## Control Panel

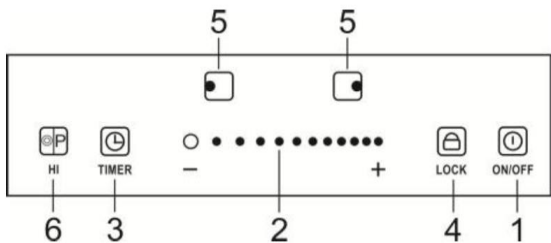

1. ON/OFF
2. Power Slider Control
3. Timer Control
4. Child Lock
5. Heating Zone
6. Boost / Dual zone Control

## Using the Touch Controls

- The controls respond to sensor touch, so you don't need to apply any pressure.
- Use the ball of your finger, not its tip.
- You will hear a beep corresponding to the sensor touch function.
- Make sure the controls are always clean, dry, and that there is no object (e.g. a utensil or a cloth) covering them. Even a thin film of water may make the controls difficult to operate.

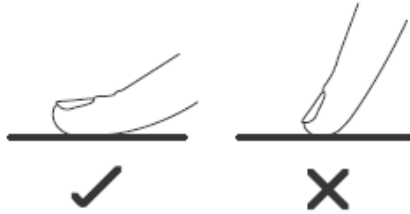

## Choosing the right Cookware

Do not use cookware with jagged edges or a curved base.



Make sure that the base of your pan is smooth, sits flat against the glass, and is the same size as the cooking zone. Always centre your pan on the cooking zone.

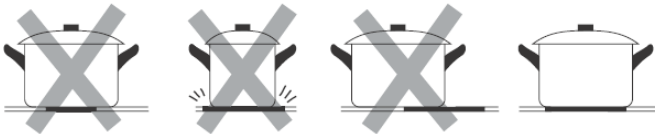

Always lift pans off the hob – do not slide, or they may scratch the glass.

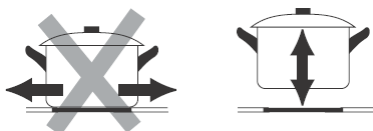

## Using Suitable Cookware for Induction

Use cookware made from ferromagnetic materials which are compatible with the induction principle. We recommend cookware made from cast iron, enamel coated steel or stainless steel cookware designed for induction cooking. Pans made of glass, ceramic and stoneware are not suitable for use in the induction zone. Cookware with aluminum bottoms is not recommended as it can cause metallic, shiny marks to appear on the glass ceramic surface which are difficult to remove.

### To test the compatibility of the cookware

Turn on the appliance and put some water in the cookware you want to check, and then place the cookware on a cooking zone at any power level. You will notice that the induction cooker remain cooking. If the power display the error code **E<sub>1</sub>**, the cookware is incompatible and unsuitable for use with induction cooking.

### To obtain best results

- Cookware with thick flat bases should be chosen for the benefit of uniform heat distribution. Avoid using cookware with rough or deformed bases.
- Use of cookware with enamel coated base can prevent the glass top from getting scratched.
- Always use pans with a diameter large enough to cover the cooking zone fully to achieve even cooking and more efficient heat distribution.



# Using your Induction/Ceramic Hob

## To start cooking

After power on, the buzzer beeps once. All the indicators light up for 1 second then go out. Indicating the induction/ceramic hob has entered the state of standby mode.

1. Touch the ON/OFF control. All the indicators show “-“.

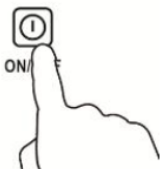

2. Place a suitable pan on the cooking zone that you wish to use. Make sure the bottom of the pan and the surface of the cooking zone are clean and dry.

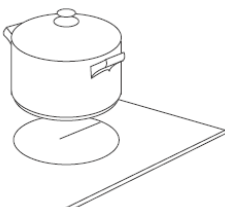

3. Touch the heating zone selection control.

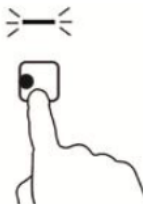

4. Select a heat setting by sliding the control panel. If you don't choose a heat setting within 1 minute, the ceramic/induction hob will automatically switch off. You will need to start again at step 1. You can modify the heat setting at any time during cooking. By slide to left or right direction, the value will adjust up or down.

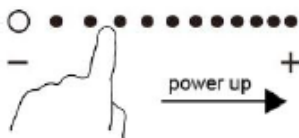
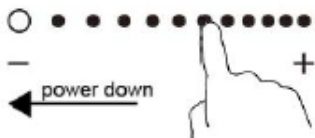

## When you have finished cooking

1. Touching the heating zone selection control that you wish to switch off.

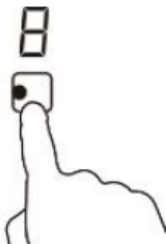

2. Turn the cooking zone off by slide to left to area "0" until display show "0".

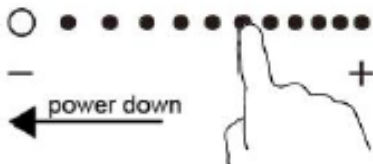

3. Turn the whole cooktop off by touching the ON/OFF control.



4. Beware of hot surfaces. "H" will show which cooking zone is hot to touch. It will disappear when the surface has cooled down to a safe temperature. It can also be used as an energy saving function if you want to heat further pans, use the hotplate that is still hot.



## Dual zone function

The dual zone consists of 2 circuits- the center zone and the outer zone. It can be used in the following modes:

- Center Zone – only first heating unit is turned on
- Extended Zone(Center + Outer) – Both first and second heating circuits are turned on

## Select the dual zone function

1. Select the zone with dual zone function required.

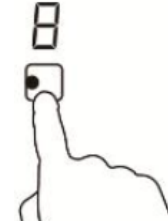

2. Touch dual zone key  until power level indication shows “=”.

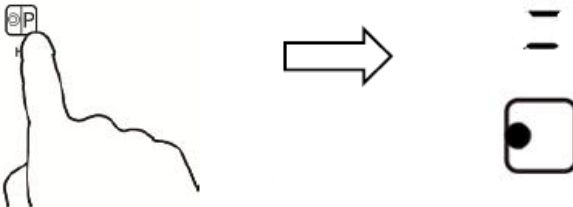

## Cancel the dual zone function

1. Select the zone with dual zone function.





2. Touch the slider bar to cancel the boost function and select the level you want to set.

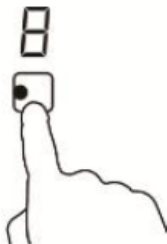

## Using the boost function

1. Select the zone with boost function required.



2. Touch boost control  until power level indication shows "P" for induction zone.

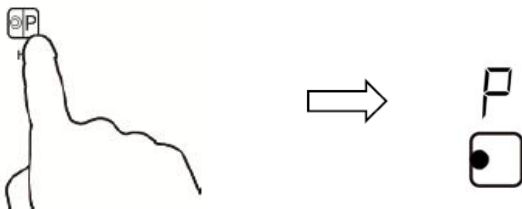

\*Boost function is only last for 5 minutes, after that the boost zone will go back to level 9 automatically.

## Cancel the boost function

1. Select the zone with boost function.



2. Touch the slider bar to cancel the boost function and select the level you want to set.



## Locking the Controls

- You can lock the controls to prevent unintended use (for example children accidentally turning the cooking zones on).
- When the controls are locked, all the controls except the ON/OFF control are disabled.

### To lock the controls

Touch and hold the key lock  button. The timer indicator will show “Lo”

### To unlock the controls

1. Make sure the ceramic/induction hob is turned on.
2. Touch and hold the key lock control for 3 seconds.
3. You can now start using your ceramic/induction hob.



When the hob is in the lock mode, all the controls are disabled except the ON/OFF function. You can always turn the hob off with the ON/OFF control in an emergency, but you shall unlock the hob first in the next operation.

## Residual Heat Warning

When the hob has been operating for some time, there will be some residual heat. The letter “H” will appear to warn you to keep away from the glass surface.



## Auto Shutdown

This safety feature occurs whenever you forget to switch off the cooking zone. The default shutdown times are shown in the table below:

Power Level	1	2	3	4	5	6	7	8	9
Default working timer (hour)	8	8	8	4	4	4	2	2	2

# Using the Timer

You can use the timer in two different ways:

- Use it as a minute minder. In this case, the timer will not turn any cooking zone off when the set time is up.
- Use it to turn off after the set time is up. You can set the timer for up to 99 minutes.

## Using the Timer as a Minute Minder

### If you are not selecting any cooking zone

1. Make sure the cooktop is turned on and the zone selection key is not activated (zone indicator show “-” and not blinking)
2. Touch the timer control, “10” will show in the timer display. “0” will flash and ready to set the timer.



3. Set the timer setting by sliding the controls to right. Now the timer will from 10 minutes become 15 minutes.

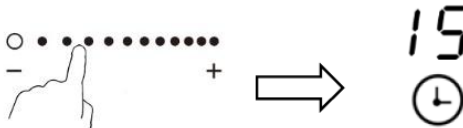

4. Touching timer control again, the first digit will flash and ready to set the timer.

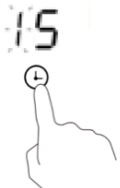

5. Set the timer setting by sliding the controls to right. Now the timer will from 15 minutes become 95 minutes.



- When the time is set, it will begin to count down immediately. The display will show the remaining time.
- Buzzer will beep for 30 seconds and the timer indicator shows “- -” when the setting time finished.



## Setting the timer to switch off one or more cooking zones

### If you are selected any cooking zone

- Touching the heating zone selection control that you want to set the time.

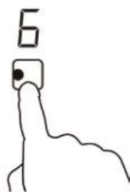

- Touch the timer control, “10” will show in the timer display. “0” will flash and ready to set the timer.



- Set the timer setting by sliding the controls to right. Now the timer will from 10 minutes become 15 minutes.

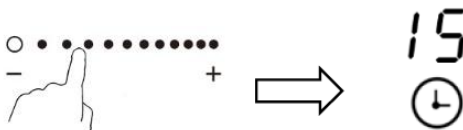

- Touching timer control again, the first digit will flash and ready to set the timer.

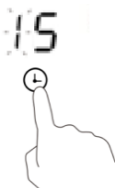

8. Set the timer setting by sliding the controls to right. Now the timer will from 15 minutes become 95 minutes.



9. When the time is set, it will begin to count down immediately. The display will show the remaining time.
10. There will be a red dot in the right bottom corner of power indicator which indicate that zone has been selected.

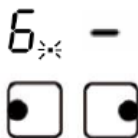

11. When cooking timer is end, the corresponding cooking zone will be switch off automatically.

### If the timer is set on more than one zone

- When you set the timer for several cooking zone, the red dot of the related cooking zone are indicated. The timer display show the “minutes” count down for the shortest timer zone and show the longest timer once the first one finished.
- For example, the left zone has been set to power 3 level, 15 minutes timer and right zone, power 6 level, 45 minutes timer. The timer display will show the shortest timer and flash the indicator as left zone.

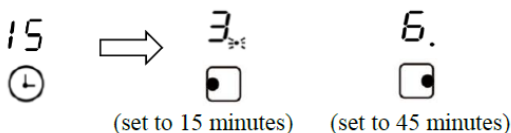

- Once the left zone timer has end, the corresponding zone will switch off. Then the right zone will show a new timer and the dot of the right zone will flash again.





## Cancel the timer

1. Touch the heating zone selection control that you wish to cancel the timer.

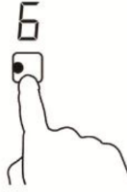

2. Touch the timer control and the indicator will flash.



3. Touch the slider control to set the timer to "00" then the timer will be cancelled.

## Cooking Guidelines



Take care when frying as the oil and fat heat up very quickly, particularly at high power levels. At extremely high temperatures oil and fat will ignite spontaneously and this presents a serious fire risk.

## Cooking Tips

- When food comes to boil, reduce the temperature setting.
- Using a lid will reduce cooking times and save energy by retaining the heat.
- Minimize the amount of liquid or fat to reduce cooking times.
- Start cooking on high setting and reduce the setting when the food has heated through.

## Simmering

- Simmering occurs below temperature around 85°C. When bubbles are just rising occasionally to the surface of the cooking liquid. It is the key to delicious soups and tender stews because the flavour develops without overcooking the food.
- You should also cook egg-based and flour-thickened sauces below boiling point.
- Some tasks including cooking rice by the absorption method may require a setting higher than the lowest setting to ensure the food is cooked properly in the time recommended.

## **Searing steak**

To cook juicy flavour steaks:

1. Defrost the meat at room temperature for about 20 minutes before cooking.
2. Heat up a heavy-based frying pan.
3. Brush both sides of the steak with oil. Drizzle a small amount of oil into the hot pan and then lower the meat onto the hot pan.
4. Turn the steak only once during cooking. The exact cooking time will depend on the thickness of the steak and how cooked you want it. Times may vary from about 2 to 8 minutes per side. Press the steak to gauge how cooked it is – the firmer it feels the more ‘well done’ it will be.
5. Leave the steak to rest on a warm plate for a few minutes to allow it to relax and become tender before serving.

## **For stir-frying**

1. Choose a compatible flat-based wok or a large frying pan.
2. Have all the ingredients and equipment ready. Stir-frying should be quick. If cooking large quantities, cook the food in several smaller batches.
3. Preheat the pan briefly and add two tablespoons of cooking oil.
4. Cook any meat firstly, put it aside and keep it warm.
5. Stir-fry the vegetables. When they are hot but still crisp, turn the cooking zone to a lower setting, return the meat to the pan and add your sauce.
6. Stir the ingredients gently to make sure they are heated through before serving.

## Heat Settings

The settings below are reference guidelines only. The exact setting will vary depending on several factors, including your cookware and the amount of food you are cooking. Experiment with the hob to find the best settings that suit you.

Heat Setting	Purpose
1 - 2	<ul style="list-style-type: none"><li>• delicate warming for small amounts of food</li><li>• melting chocolate, butter, and foods that burn quickly</li><li>• gentle simmering</li><li>• slow warming</li></ul>
3 - 4	<ul style="list-style-type: none"><li>• reheating</li><li>• rapid simmering</li><li>• cooking rice</li></ul>
5 - 6	<ul style="list-style-type: none"><li>• pancakes</li></ul>
7 - 8	<ul style="list-style-type: none"><li>• sauteing</li><li>• cooking pasta</li></ul>
9	<ul style="list-style-type: none"><li>• stir-frying</li><li>• searing</li><li>• bringing soup to the boil</li><li>• boiling water</li></ul>

## Error Code

If an abnormal situation come up, the induction zone will enter the protective status automatically and display corresponding code as below:

Error Code	Possible causes	What to do
E2/E3	Abnormal supply voltage	Please inspect the supply voltage and power on after the power supply is normal.
E4/E5	Temperature sensor failure	Please contact technician.
E6/E9	Bad induction hob heat radiation	Please restart after the induction hob cools down.
E7/E8	Temperature sensor IGBT failure	Please contact technician.

# Cleaning and Maintenance

What?	How?	Important!
Everyday soiling on glass (fingerprints, marks, stains left by food or non-sugary spillovers on the glass)	<ol style="list-style-type: none"> <li>1. Switch off the power.</li> <li>2. Apply a cooktop cleaner while the glass is still warm. (Not hot!)</li> <li>3. Rinse and wipe dry with a clean cloth or paper towel.</li> <li>4. Switch the power to the cooktop back on.</li> </ol>	<ul style="list-style-type: none"> <li>• When the power is switched off, there will be no 'hot surface' indication but the cooking zone may still be hot! Take extreme care.</li> <li>• Heavy duty scourers, some nylon scourers and harsh/abrasive cleaning agents may scratch the glass. Always read the label to check if the cleaner or scourer used is suitable.</li> <li>• Never leave cleaning residue on the cooktop. The glass may become stained.</li> </ul>
Boil overs, melts, and hot sugary spills on the glass surface.	<p>Remove these immediately palette knife or razor blade scraper suitable for glass cooktops, but beware of hot cooking zone surfaces:</p> <ol style="list-style-type: none"> <li>1. Switch off the power of the cooktop from the wall socket.</li> <li>2. Hold the blade or utensil at a 30° angle and scrape the soiling or spill to a cool area of the cooktop.</li> <li>3. Clean the soiling or spill up with a dish cloth or paper towel.</li> <li>4. Follow steps 2 to 4 for "Everyday soiling on glass" above.</li> </ol>	<ul style="list-style-type: none"> <li>• Remove stains left by melts and sugary food or spillovers as soon as possible. If left to cool on the glass, they may be difficult to remove or even permanently damage the glass surface.</li> <li>• Cut hazard: When the safety cover is retracted, the blade in a scraper is razor-sharp. Use with extreme care and always store safely and out of reach of children.</li> </ul>
Spill overs on the touch controls	<ol style="list-style-type: none"> <li>1. Switch off the power of the cooktop.</li> <li>2. Soak up the spill.</li> <li>3. Wipe the touch control area with a clean damp sponge or cloth.</li> <li>4. Wipe the area completely dry with a paper towel.</li> <li>5. Switch the power to the cooktop back on.</li> </ol>	<ul style="list-style-type: none"> <li>• The cooktop may beep and turn itself off, and the touch controls may not function while there is liquid on them.</li> <li>• Make sure you wipe the touch control area dry before turning the cooktop back on.</li> </ul>

## Troubleshooting Guides

<b>Problem</b>	<b>Possible causes</b>	<b>What to do</b>
The cooktop cannot be turned on.	No power.	Make sure the cooktop is connected to the power supply and it is switched on. Check whether there is a power outage in your area. If you've checked everything and the problem persists, contact the service center.
The touch controls are unresponsive.	The controls are locked.	Unlock the controls. See section 'Using your cooktop' for instructions.
The touch controls are difficult to operate.	There may be a slight film of water over the controls or you may be using the tip of your finger when touching the controls.	Make sure the touch control area is dry and use the ball of your finger when touching the controls.
The glass is being scratched.	Rough-edged cookware.  Unsuitable, abrasive scourer or cleaning products being used.	Use cookware with flat and smooth bases. See 'Choosing the right cookware'.  See 'Cleaning and maintenance'.
Some pans make crackling or clicking noises.	This may be caused by the construction of your cookware (layers of different metals vibrating differently).	This is normal for cookware and does not indicate a fault.

## Technical Specification

Model	EICH-G3622ST(BK)
Cooking Zones	2 Zones
Supply Voltage	220-240V~ 50/60Hz
Total Power	3600W
Product Size (W X D X H)	730 x 420 x 58 mm
Built-in Dimension (W X D)	680 X 380 mm





**ELBA**