

RADIUS 70

ELBA

MODEL: EPS-E9302TM

CUT OUT DIMENSION

460mm

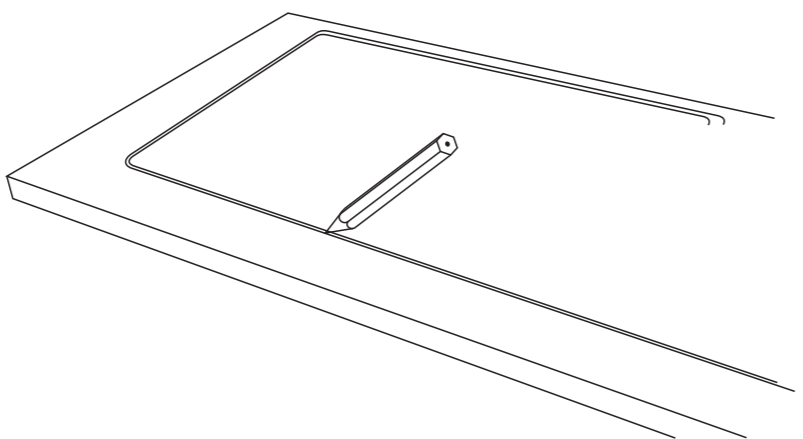

Step 1: Mark the cut-out line on the bench according to the cut-out dimension

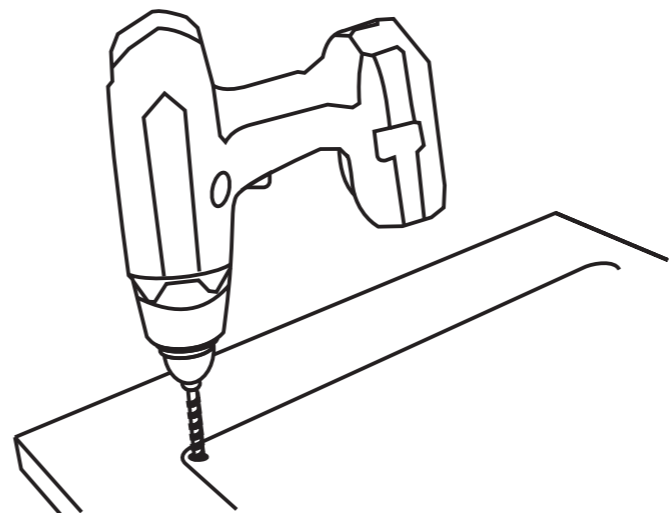

Step 2: Drill holes for cutting work

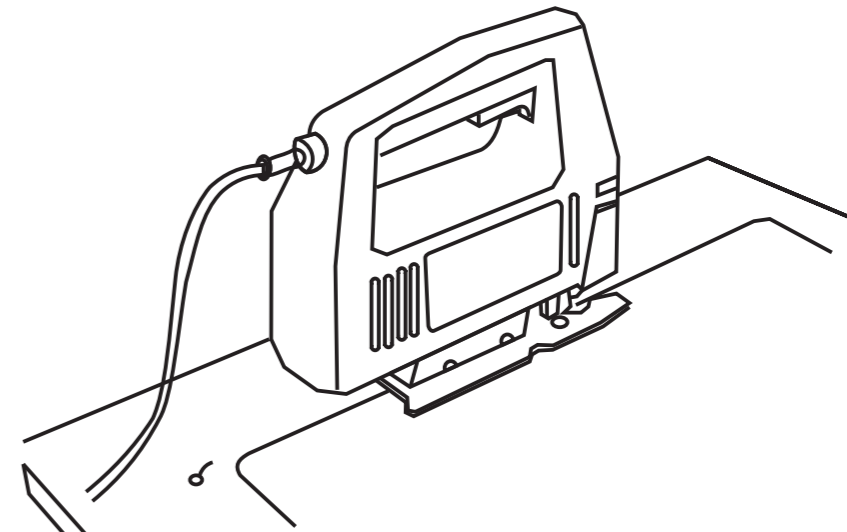

Step 3: Cut a built-in hole along the line with cutting tools.

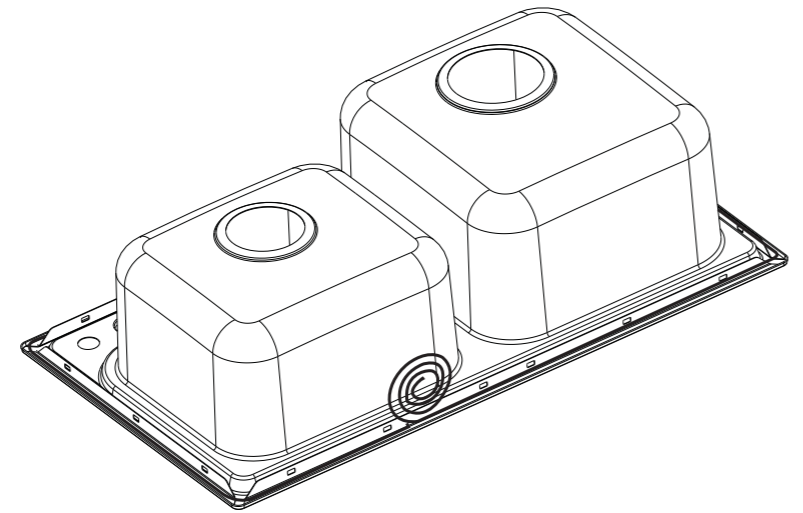

Step 4: Turn the sink upside down. Apply the sealing tape on the sink along the edges.

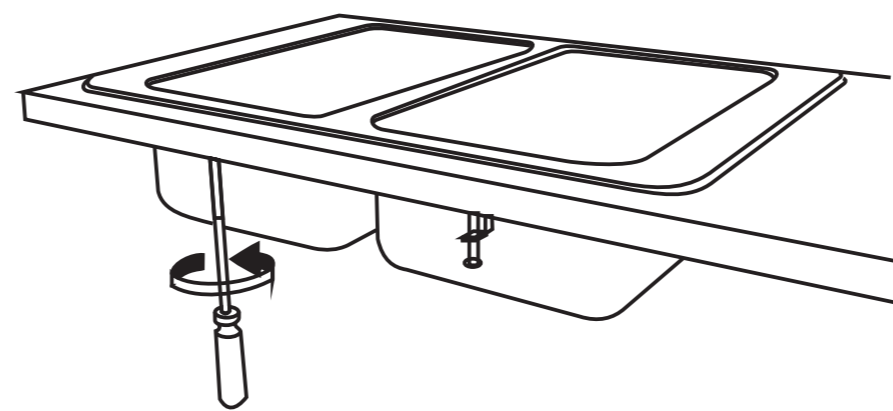

Step 5: Fix the sink on the holes with mounting clips



WARNING

The sink should only be installed by a qualified installer. Pls wear protective gloves before installing.

910mm