

ELBA

MULTI DOOR REFRIGERATOR MODEL: EMR-H5244D(BS)

Owner's Manual

Please read this manual carefully before operating your set.

Retain it for future reference.

Record model number and serial number of the set.

See the label attached on the set and quote this information to your dealer when you require service.

For The Warranty Terms & Conditions, Please Refer To Warranty Certificate

CONTENTS

1. SAFETY PRECAUTIONS	1
2. INSTALLATION	2-3
3. PRODUCT DESCRIPTION	4
3.1 OVERVIEW.....	4
3.2 CONTROL PANEL.....	5
3.3 OPERATING THE CONTROL PANEL.....	6
3.4 MEAT AND VEGETABLES CONVERSION CONTROL.....	7
3.5 MODE DESCRIPTION.....	7-8
3.6 COMPARTMENTS OVERVIEW.....	8-9
4. DAILY TIPS	10
4.1 FREEZING FRESH FOOD.....	10
4.2 RECOMMENDATIONS FOR PRESERVATION OF FROZEN FOOD.....	10
4.3 DEFROSTING.....	10
5. CLEANING AND MAINTENANCE	11
6. TROUBLESHOOTING	12
7. MAIN SPECIFICATION	12

REMOVE ALL PACKING MATERIALS FROM THIS APPLIANCE BEFORE USING IT. THIS APPLIANCE MUST BE INSTALLED ON A FLAT SURFACE. PLEASE ENSURE THE ELECTRICITY SUPPLY TO THIS APPLIANCE IS DISCONNECTED BEFORE INSTALLING.

Please read this instruction carefully. It is advisable to keep this instruction manual in a safe place for future reference.

1. SAFETY PRECAUTIONS

- Keep this appliance out of reach from children. Do not let them to operate the appliance without supervision.
- Check the current rating on the rating plate and make sure the current supplied is matched with the appliance before using.
- This appliance must be stationed at least 10cm away from the surrounding objects. There should not be anything to be placed on top of the appliance.
- This appliance is for household and indoor use only.
- This appliance is not intended for use by person (including children) with reduced physical, sensory or mental capabilities unless they have been given supervision or instruction concerning use of the appliance by a person responsible for their safety.
- If the power cord or plug is damaged, it must be replaced by the service centre or a qualified service technician to avoid hazard.
- This appliance should not be placed near possible heating resources or under direct sunlight to avoid decreasing the efficiency of refrigeration.
- This appliance should be placed in a cool dry place where there is no vicinity of water splashing or high humidity.

WARNING - to reduce the risk of fire, electrical shock or injury to persons or property, please read and follow below instructions carefully:

- Always operate the appliance from a power source of the same voltage, frequency and rating as indicated on the appliance identification marking.
- Do not operate this appliance if it has malfunctioned, damaged cord or plug or appears damaged in any way. Return the complete product to the place of purchase for inspection, repair or replacement.
- This appliance should not be used in the immediate vicinity of water, such as bathtub, washbowls, swimming pool etc. where the likelihood of splashing could occur.
- Always switch off and unplug the plug from outlet when not in use and before cleaning.
- When the appliance is operating, the condenser and compressor will be hot.
- This appliance must be grounded and the ground wire should not be connected to any heating pipe and gas pipe.
- Do not place carbonated or fizzy drinks into the freezer.
- Do not attempt to touch the freezer when your hand is damp or wet as this could cause skin abrasions or frost burns.
- This appliance is designed to operate in ambient temperatures (surrounding air temperature) between 16°C and 32°C.
- This appliance will create frost in the door seal if the appliance door seal is not in good condition or door is opened frequently.

2. INSTALLATION

1. This appliance is heavy. Care should be taken when moving it.
2. When you transport the appliance, the angle between the compartment body and the ground should not be less than 45°.

WARNING: *Never put the appliance upside down.*

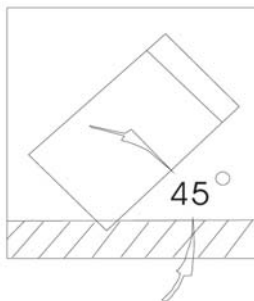

3. Once the appliance has landed properly on a flat and stable surface, remove all the packing material including any plastic packaging material in the appliance.
4. Keep your refrigerator away from heat sources, humid places and direct sunlight. Please avoid your refrigerator away from heat sources such as hobs, ovens, central heater and stoves.
5. There must be appropriate air ventilation around your refrigerator in order to achieve an efficient operation. The back of the appliance should be keep at least 100mm distance to a wall for ventilation purpose. Do not place your product on the materials such as rug or carpet.

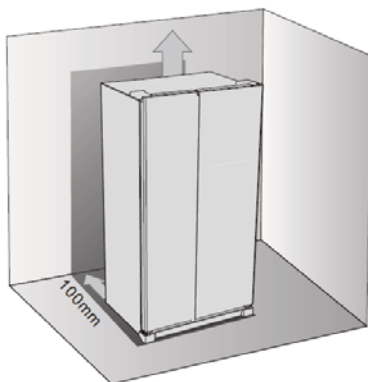

6. Allow the side of the appliance keep at least 50mm distance when installing and allow the door be open 130°

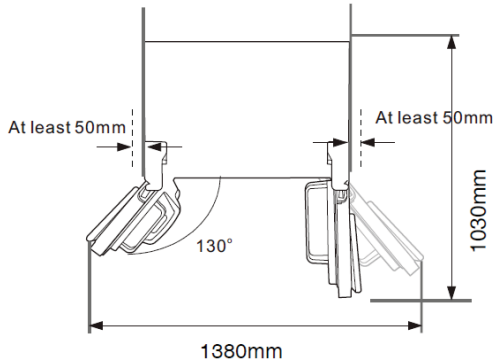

7. Please make sure the appliance levelling feet according to the installation condition, please adjust the feet to the suitable level. If the appliance not level, the doors and magnetic seal alignments will not be covered properly.

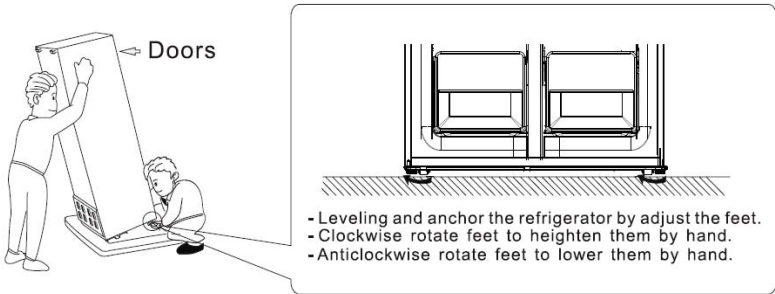

8. Wash the inside of the appliance with lukewarm water with a little bicarbonate of soda added (5ml to 0.5 litre of water). Do not use soap, detergent or any abrasive cleaner to wash. Dry the appliance thoroughly after cleaning.
9. Open the fridge door for ventilation of internal compartments. Idle for 4 hours before connecting the electrical mains to ensure the refrigerant in the compressor has settled well.
10. Connect the electrical mains and switch on the power for 4 hours initially before adding any goods. Make sure the ground is solid and will not vibrate when the appliance is operating.
11. If these temperatures are exceeded i.e., colder or warmer, the appliance will not operate correctly. Should the ambient temperatures be exceeded for long periods, the temperature in the freezer section will rise above $\leq -18^{\circ}\text{C}$ and food spoilage may occur.

3. PRODUCT DESCRIPTION

3.1 Overview

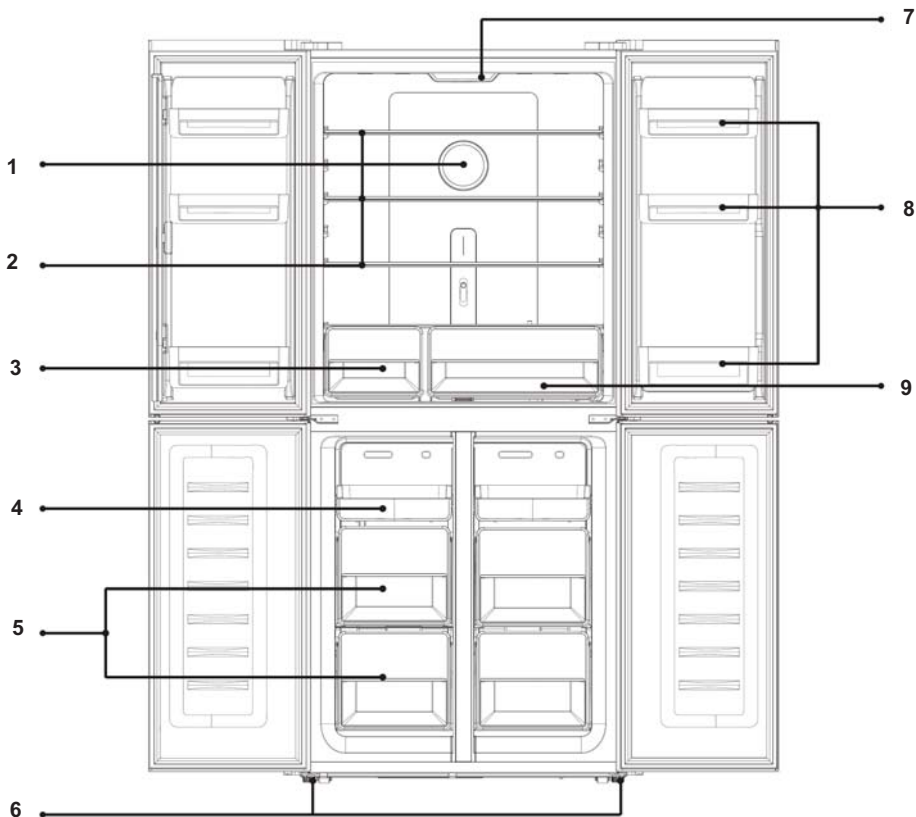

- 1. Anti-Bacteria and Deodorization Device
- 2. Tempered Glass Shelves
- 3. Conversion Room
- 4. Sliding Tray
- 5. Freezer Drawer
- 6. Level feet
- 7. LED Light
- 8. Balcony / Rack
- 9. Moist Fresh Zone

* The above image is for reference purpose only. The actual appliance maybe slightly different.

3.2 Control Panel

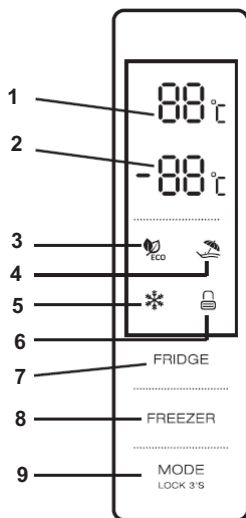

1. Fridge Compartment Temperature Display
2. Freezer Compartment Temperature Display
3. ECO Mode
4. Holiday Mode
5. Super Freezing Mode
6. Child Lock
7. Temperature Control for Fridge Compartment
8. Temperature Control for Freezer Compartment
9. Mode / Lock / Unlock

3.2.1 Display

The control panel display will be lit up for 2 minutes once the door is opened. The display light will be out after 2 minutes without any operation.

3.3 Operating the Control Panel

3.3.1 Temperature Control of Fridge Compartment

The freezer control panel situated in the appliance regulates the temperature setting. The internal temperature is controlled by a control panel. Temperature setting can choose from 2°C, 3°C, 4°C, 5°C, 6°C, 7°C, 8°C and "OFF" according to each temperature setting by touching the panel. The appliance will be turn off completely if select to "OFF". The selected temperature will be set once the display temperature flash for 5 seconds.

3.3.2 Temperature Control of Freezer Compartment

The fridge control panel situated in the appliance regulates the temperature setting. The internal temperature is controlled by a control panel. Temperature setting can choose from -14°C to -22°C according to each temperature setting by touching the panel. The selected temperature will be set once the display temperature flash for 5 seconds.

3.3.3 Turn Off the Fridge Compartment

Select the temperature control of fridge compartment by select the "OFF" setting. The display temperature flash for 5 seconds and the appliance will completely turn off.

3.3.4 Mode

Press "Mode" button one time to enter the specific mode program. The sequence of the mode is start from "ECO Mode", "Holiday Mode", to "Super Freezing Mode". The selected mode will be set once the selected mode flash for 5 seconds.

3.3.5 Lock / Unlock Control Panel

Press and hold "Mode" button for 3 seconds to enter the child lock mode for control panel. All the functions unable to change or set.

Press and hold "Mode" button for 3 seconds to unlock the child lock mode for control panel. All the functions is back to control.

* The system will automatically locked after 25 seconds from the last key operation. The display light for panel will be out at 30 seconds after the panel locked.

3.3.6 Pressing the button

A short beep sound will be alert when each button press.

3.4 Meat & Vegetables Conversion Control

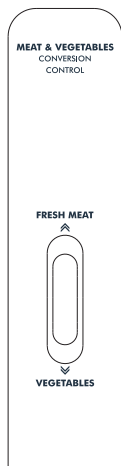

This individual conversion room can be switch according to user needs and temperature will be adjusted accordingly.

1. When the button turn to **“Fresh Meat”** position, the temperature will be turn to a lower temperature and this zone will become a place to storage a short-term of fish or other fresh food. The food will remain fresh but not in frozen condition. This ideally store the goods with preserved lead time not more than 3 days so that to ensure the freshness.
2. When the button turn to **“Vegetables”** position, the temperature will be turn into a temperate that suitable to keep fruits and vegetables. This zone allow user to have a dual storage zone for fruits and vegetables when the place is not enough to use in Moist Fresh Zone.

3.5 Mode Description

ECO Mode

Press “Mode” button to enter the ECO mode program. When the ECO mode is selected, the ECO mode icon will flash for 5 seconds and the selected mode has been set.

System will automatically turn the fridge temperature to 5°C and freezer temperature to -18°C.

Press “Mode” button again or change any temperature to exit ECO mode.

Holiday Mode

Press "Mode" button to enter the Holiday mode program. When the Holiday mode is selected, the Holiday mode icon will flash for 5 seconds and the selected mode has been set.

System will automatically turn the fridge temperature to 17°C and freezer temperature remain unchanged.

Press "Mode" button again or change any temperature to exit Holiday mode.

Super Freezing Mode

Press "Mode" button to enter the Super Freezing mode program. When the Super Freezing mode is selected, the Super Freezing mode icon will flash for 5 seconds and the selected mode has been set. System will automatically turn the freezer temperature to -25°C and fridge temperature remain unchanged. The compressor will keep on working so that the temperate will achieve the desire temperate. The freezing period is more than 50 hours.

Press "Mode" button again or change any temperature to exit Super Freezing mode.

* To ensure the lifespan of the compressor, it is necessary to exit the super freezing mode after 50 hours.

3.6 Compartments Overview

Moist Fresh Zone

Moist fresh zone is designed specially to keep the vegetables fresh without losing their humidity and maintain the freshness. For this purpose, cool air circulation is intensified around the moist fresh zone in general. This compartment is the coolest place in the fridge to store the fruits and vegetables.

Humidity	Ideal goods
Low	Pears, apples, grapes, mushrooms, peppers, berries and etc.
High	Carrots, leafy greens, spinach, arugula, basil, broccoli and etc.

Humidity Control Panel

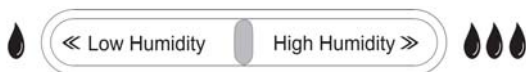

Low Humidity (Fruits): Turn the humidity level to left and let more cool air enter into fresh zone.

High Humidity (Vegetables): Turn the humidity level to right and let less cool air enter into fresh zone.

Twist Ice Maker

Remove the ice container from the freezer compartment. Then fill the ice container with water. Place the ice container in the freezer compartment. About two hours later, the ice is ready to serve. Remove the ice container from the freezer compartment and bend it over the ice storage plate. Ice cubes will easily fall down to the ice storage plate.

Other Compartment

The below chart is the suggested foods to be stored in each compartment.

Compartment	Suggested Foods to place
Freezer Compartment Shelves	Various frozen food such as meat, fish, ice cream, prawn and etc.
Egg Tray	Egg
Fridge Compartment Shelves	Food in pans, covered plates and closed containers
Fridge Compartment Balcony / Rack	Small and packaged food or drinks (such as milk, fruit juice, jam and etc.)
Moist Fresh Zone	Vegetables and fruits
Conversion Room	Dairy products (cheese, butter and etc.) / Meat / Vegetables and fruits

4. DAILY TIPS

4.1 Freezing fresh food

- It is recommended to wrap or cover the food before placing them in the refrigerator.
- Hot food must cool down to the room temperature before putting them in the refrigerator.
- The food that you want to freeze must be fresh and in good quality.
- Food must be divided into portions according to the family's daily or meal based consumption needs.
- The food must be packaged in an airtight manner to prevent them from drying even if they are going to be kept for a short time.
- To minimize moisture loss, fruit and vegetables should be loosely enclosed in a plastic material. Example: wrap or bags without sealing and place in the moist fresh zone.
- Please observe the following instructions to obtain the best results.
 1. Do not freeze too large quantities of food at one time. The quality of the food is best preserved when it is frozen right through to the core as quickly as possible.
 2. Placing warm food into the freezer compartment causes the cooling system to operate continuously until the food is frozen solid.
 3. Do not block the outlet and inlet of the cool air circulating, otherwise the foods will not be evenly cooled throughout the refrigerator.
 4. Take special care not to mix already frozen food and fresh food.
 5. Keep the door securely closed.

4.2 Recommendations for preservation of frozen food

- Frozen food must be used immediately after they are thawed and they should never be re-frozen.
- To ensure that the high quality achieved by the frozen food manufacturer and the food retailer is maintained, the following should be remembered:
 1. Put packages in the freezer as quickly as possible after purchase.
 2. Ensure that contents are labelled and dated.
 3. Do not exceed "Best Before", "Use By" dates on the product packaging date.

4.3 Defrosting

The freezer compartment defrosts automatically

NOTE: If there is an electricity cut-off, please wait 10 minutes before operating the appliance again to avoid damage to the compressor.

5. CLEANING AND MAINTENANCE

1. Always ensure that the electrical main is turned off and unplugged before cleaning the appliance.
2. Remove the tempered glass shelf by lifting up and pull out slowly.



3. Remove each balcony / rack by lifting up and pull out slowly.

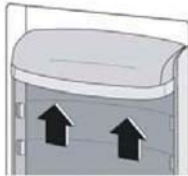

4. Wrap the food and keep them in a cool place.
5. Do not use chemical, steel, wooden or abrasive cleaners to clean the appliance.
6. Never use sharp instruments to scrape off frost or ice.
7. After cleaning, wipe the appliance until it is completely dry.
8. Use warm water to clean the oil and stains on the gasket in order to keep its elasticity.
9. This appliance should be serviced by an authorised service technician. Please contact the service centre if you required service on the appliance.
10. Under no circumstances should you attempt to repair the appliance by yourself.
11. Repairs carried out by inexperienced persons may cause injury or serious malfunctioning.

6. TROUBLESHOOTING

Failure	Failure Reason	Possible Solution
Appliance does not work	The plug is not plugged or is loose.	Plug in and turn on the power.
	The fuse on the plug has blown.	Change the fuse.
Appliance freezes or too cold	Temperature is set too cold.	Turn the temperature regulator to a warmer setting.
The food is not frozen enough	Temperature is not properly set.	Please refer to control panel page to set the correct temperature.
	Door is opening too regular.	Reduce the frequency to open the door.
	Large quantity of warm food was placed in the fridge within last 4 hours.	Turn the temperature to a colder setting for a temporary cool down.
	Directly under sunlight or too close to heat resources.	Do not install the appliance under direct sunlight.
Heavy build up of frost on the door seal	Door seal is not tight.	Please contact technician to replace a new door seal if necessary.
Unusual noises	Appliance is not level.	Readjust the feet.

7.0 MAIN SPECIFICATION

Model No	:EMR-H5244D(BS)
Gross Capacity	: 520 Litres
Net Capacity	: 401 Litres
Climatic Type	: T
Insulation Class	: CLASS I
Total Input Power	: 180 W
Rated Voltage	: 220-240V / 50Hz
Rated Current	: 1.5 A
Refrigerant	: R600a (66g)
Product Dimension (mm):	795 (W) x 700 (D) x 1800 (H)

NOTICE

This appliance must not be disposed together with domestic waste. It has to be disposed at an authorized place for recycling of electrical and electronic appliances. By collecting and recycling waste, you help to save natural resources and make sure the appliance is disposed in an environmental friendly and healthy way.



ELBA